

Luminous Infra-red Gas Heaters



MANUAL for INSTALLATION, RUNNING and MAINTENANCE



“Infra HT.2” and “Infra HT.2 eco”

“Infra HT.2 PIEZO” and “Infra HT.2 eco PIEZO”

“Infra HT.2 DS”

CONTENT

For Your safety	2
Introduction / before starting installation	3
Plate label	4
Warrenty terms	4
Technical data	5
. heaters Infra HT. 2 and Infra HT.2 eco	5
. heaters Infra HT. 2 PIEZO and Infra HT.2 eco PIEZO	6
. heaters Infra HT. 2 DS	7
Installation	8
. ventilation	8
. positioning	9 and 10
. minimum distance to people	11
. minimum distance to inflammable surfaces	12
. gas connection	13
. SIT control unit, electric connection	14
. SIT control unit, wiring diagram ON-OFF version	15
. SIT control unit, H / L version	16 and 17
. SIT control unit, wiring diagram H / L version	18
Put in opeartion and First Start-up	19
. heaters Infra HT. 2 , Infra HT.2 eco and Infra HT. 2 DS	20
. heaters Infra HT. 2 PIEZO and Infra HT.2 eco PIEZO	21
Maintenance and Annual Check	22
. nozzle replacement	23
. trouble shooting	24
CE certificate	25 and 26
Service sheet	27

FOR YOUR SAFETY



In case of gas smell : vent the ambient, do not start apparatus or electric switches, leave the building; then contact gas company and follow their instruction; if not possible, contact Firemen

IMPORTANT: heaters **MUST NOT be used in domestic environments**. This unit will be devoted only to the use for which it was expressly provided, **all other uses will be considered improper and therefore dangerous**.

IMPORTANT : heaters **MUST NOT be used in ambients with inflamable materials, liquids or vapours** : non-compliance with these requirements may be cause of death, injury to persons or damage to things.



GENERAL INSTRUCTIONS for INSTALLER, USER and MAINTENANCE PERSONNEL

Thank you for having chosen MARK BV products !!! We are pleased to have You among our Customers, and we do think that use of our heaters will be fully satisfactory. To keep heaters perfectly working and safe, we ask you to follow the instructions of this handbook and to have all installation and maintenance operations carried out only by skilled personnel. **In case of non-compliance with the following instructions, the warranty covering the products will be null and void.**

IMPORTANT!!! This manual is an integral and essential to the product and must be delivered to the user. Please read the warnings contained in the manual **before starting the installation** as provide important information concerning the safety of installation, use and the necessary maintenance operations to be conducted over MARK BV heaters. **Store carefully the manual for further consultations.**

Installation should be done in accordance with the Regulations in force, as instructed by the Manufacturer and by professionally qualified staff; for professionally qualified staff means that having specific technical competence in the field of components plants and, in particular, the Technical Service Centres authorized by MARK BV. These devices **must be installed only in premises with a sufficient ventilation.** An incorrect installation can cause damage to people, animals and things, for which the Manufacturer is not responsible.

After you have removed any element of packing, ensure the integrity of the contents; in case of doubt not use the equipment and contact the Manufacturer. The elements of packaging are potentially dangerous and therefore should not be left within the reach of children and must be disposed of according to regulations.

In case of failure and/or malfunction of the appliance, turn it off refraining from any attempt to repair or direct intervention; the eventual repair of products MARK BV should be performed only by an authorized Service Center by the Manufacturer using only original spare parts. In each case, call professionally qualified staff.

To ensure the efficiency of the appliance and for its proper functioning periodic maintenance is essential, performed by professionally qualified personnel, following the directions of Manufacturer. Before carrying out any operation or maintenance of cleanliness, **wait for the unit is cold, disconnect the unit from the main power supply acting on the plant switch, close gas supply acting on cut-off devices.** If the unit is equipped with accessories or modification kits (including electric) must be used genuine spare parts and accessories.

Failure to comply with the directions above **may jeopardize the safety of the appliance.**

When you decide to stop using the apparatus, will render harmless all parties that may be a source of potential danger. If the unit should be sold or transferred to another owner, always make sure this manual will accompany the equipment so that it can be consulted by the new user and / or maintainer.

It is excluded any contractual liability and extra-contractual the Manufacturer for damage caused by errors in the installation and use, and from non-compliance with the instructions given by the Manufacturer. The installation and maintenance **must be carried out in accordance with regulations in the country of installation and the state of the art.**

Plate label

Each unit is delivered complete with a plate of technical data, do not removable and placed at the head of the heater.

note - A1 apparatus, gas category II 2L3B

MARK BV Beneden Verlaat 87 – 89 9645BM Veendam (NL)	Dit toestel moet door een bevoegd persoon in overeenstemming met de geldende regelgeving geïnstalleerd worden. Het toestel is alleen bedoeld voor ruimteverwarming in goed geventileerde ruimten. Niet gebruiken in kelders of ruimten beneden het maaiveld. Niet voor huishoudelijk gebruik of verwarmen van woongedeelten in woningen. Lees voor het installeren de bijgeleverde handleiding.	
Model: INFRA HT 16.2 eco	CE 0694/08	
Gascategorie: I 2L3B / P		
Pin code: 0694BS0965	Opgenomen elektr. vermogen (W): 18	
Land van bestemming : NL	Beschermingsklasse : IP20	
Toestelcategorie : A1	Gassoort : G25	
Nom. belasting MAX BW (kW): 26.0	Gasaanvoerdruk (mbar): 25.0	
Nom. belasting MAX OW (kW): 23.4	Branderdruk MAX (mbar): 14.0	
Nom. belasting MIN BW (kW): –	Branderdruk MIN (mbar): –	
Nom. belasting MIN OW (kW): –	Spuitstukdiameter (mm) : 4.30	
Voltage (V): 230	Gasverbruik MAX (m3/h) : 2.88	
Frequentie (Hz): 50	Gasverbruik MIN (m3/h) : –	
	NOx categorie : 4	
TOESTEL MAG NIET TOEGEPAST WORDEN IN EEN HUI SHOUDELIJKE OMGEVING		

Plate label (exemple : Infra HT 16.2 eco, G25 natural gas)

Warrenty

MARK BV guarantees its products, whether installed by authorized personnel, for a period of 12 months from the date of the first start-up and no later than 18 months from the date of sale.

The warranty does not cover the components supplied by third parties, these are subject to the conditions of the original warranty.

The guarantee is only the free supply on Ex-Works basis, of parts with manufacturing or workmanship defects.

The guarantee does not cover disadvantages due to carelessness, incorrect setting, misuse of the unit or fortuitous accidents, and not dependent on imperfection processing or defective materials, and those due to dismantling or change without prior authorization from MARK BV.

The proper functioning of the apparatus depends on a proper installation and an start-up. Failure to comply with these rules immediately involves the decay of the guarantee, and therefore of responsibility by the manufacturer.

TECHNICAL DATA

series "Infra HT.2" and "Infra HT.2 eco"

Model, series Infra HT.2		4.2	6.2	8.2	10.2	12.2	16.2	10+10.2	12+12.2	16+16.2
Weight, series Infra HT.2	(kg)	13	16	19	21	25	31	37	44	52
Model, series Infra HT.2 eco		4.2 e	6.2 e	8.2 e	10.2 e	12.2 e	16.2 e	10+10.2 e	12+12.2 e	16+16.2 e
Weight, series Infra HT.2 eco	(kg)	8	10	12	14	17	21	29	34	40
Number of ceramic plates	n°	4	6	8	10	12	16	20	24	32
Electric feeding		230 Volt - single phase - 50 Hz								
NOx class		4	4	4	4	4	4	4	4	4
GAS G20										
Heat input MAX (Hs)	(kW)	7,2	9,6	16,1	18,3	22,2	26,0	36,6	44,4	52,0
Heat input MAX (Hi)	(kW)	6,5	8,6	14,5	16,5	20,0	23,4	33,0	40,0	46,8
Heat input MIN (Hs)	(kW)	5,4	7,2	12,1	13,8	16,7	19,5	27,6	33,4	39,0
Heat input MIN (Hi)	(kW)	4,9	6,5	10,9	12,4	15,0	17,6	24,8	30,0	35,2
GAS supply pressure	(mbar)	20,0	20,0	20,0	20,0	20,0	20,0	20,0	20,0	20,0
NOZZLE pressure MAX	(mbar)	15,5	14,0	14,0	15,0	16,0	14,0	15,0	16,0	14,0
NOZZLE pressure MIN	(mbar)	8,5	7,5	8,0	9,0	9,5	8,0	9,0	9,5	8,0
Gas consumption MAX	(Sm ³ /h)	0,69	0,91	1,53	1,75	2,12	2,48	3,50	4,24	4,96
Gas consumption MIN	(Sm ³ /h)	0,52	0,69	1,15	1,31	1,59	1,86	2,62	3,18	3,72
Nozzle diameter	(mm)	2,10	2,45	3,10	3,30	3,50	3,90	2 x 3,30	2 x 3,50	2 x 3,90
GAS G25										
Heat input MAX (Hs)	(kW)	7,2	9,6	16,1	18,3	22,2	26,0	36,6	44,4	52,0
Heat input MAX (Hi)	(kW)	6,5	8,6	14,5	16,5	20,0	23,4	33,0	40,0	46,8
Heat input MIN (Hs)	(kW)	5,4	7,2	12,1	13,8	16,7	19,5	27,6	33,4	39,0
Heat input MIN (Hi)	(kW)	4,9	6,5	10,9	12,4	15,0	17,6	24,8	30,0	35,2
GAS supply pressure	(mbar)	25,0	25,0	25,0	25,0	25,0	25,0	25,0	25,0	25,0
NOZZLE pressure MAX	(mbar)	13,7	14,0	14,5	16,0	16,0	14,0	16,0	16,0	14,0
NOZZLE pressure MIN	(mbar)	8,3	7,5	8,5	9,5	9,5	8,0	9,5	9,5	8,0
Gas consumption MAX	(Sm ³ /h)	0,80	1,06	1,78	2,03	2,46	2,88	4,06	4,92	5,76
Gas consumption MIN	(Sm ³ /h)	0,60	0,80	1,34	1,53	1,85	2,17	3,06	3,70	4,34
Nozzle diameter	(mm)	2,30	2,70	3,40	3,60	3,80	4,30	2 x 3,60	2 x 3,80	2 x 4,30
GAS G30										
Heat input MAX (Hs)	(kW)	7,0	9,3	13,5	17,9	21,7	25,4	35,8	43,4	50,8
Heat input MAX (Hi)	(kW)	6,5	8,6	12,5	16,5	20,0	23,4	33,0	40,0	46,8
Heat input MIN (Hs)	(kW)	5,3	7,0	10,2	13,4	16,3	19,1	26,8	32,6	38,2
Heat input MIN (Hi)	(kW)	4,9	6,5	9,4	12,4	15,0	17,6	24,8	30,0	35,2
GAS supply pressure	(mbar)	30,0	30,0	30,0	30,0	30,0	30,0	30,0	30,0	30,0
NOZZLE pressure MAX	(mbar)	28,2	28,0	28,0	28,5	28,1	27,5	28,5	28,1	27,5
NOZZLE pressure MIN	(mbar)	16,5	16,0	15,5	16,0	16,0	16,5	16,0	16,0	16,5
Gas consumption MAX	(kg/h)	0,51	0,68	0,99	1,30	1,58	1,84	2,60	3,16	3,68
Gas consumption MIN	(kg/h)	0,39	0,51	0,74	0,98	1,18	1,39	1,96	2,36	2,78
Nozzle diameter	(mm)	1,30	1,50	1,80	2,10	2,30	2,45	2 x 2,10	2 x 2,30	2 x 2,45
GAS G31										
Heat input MAX (Hs)	(kW)	7,0	9,3	13,5	17,9	21,7	25,4	35,8	43,4	50,8
Heat input MAX (Hi)	(kW)	6,5	8,6	12,5	16,5	20,0	23,4	33,0	40,0	46,8
Heat input MIN (Hs)	(kW)	5,3	7,0	10,2	13,4	16,3	19,1	26,8	32,6	38,2
Heat input MIN (Hi)	(kW)	4,9	6,5	9,4	12,4	15,0	17,6	24,8	30,0	35,2
GAS supply pressure	(mbar)	37,0	37,0	37,0	37,0	37,0	37,0	37,0	37,0	37,0
NOZZLE pressure MAX	(mbar)	36,2	35,7	35,7	36,2	36,2	35,7	36,2	36,2	35,7
NOZZLE pressure MIN	(mbar)	22,0	20,0	20,0	20,0	20,0	20,5	20,0	20,0	20,5
Gas consumption MAX	(kg/h)	0,50	0,67	0,97	1,28	1,55	1,82	2,56	3,10	3,64
Gas consumption MIN	(kg/h)	0,38	0,50	0,73	0,96	1,16	1,37	1,92	2,32	2,74
Nozzle diameter	(mm)	1,30	1,50	1,80	2,10	2,30	2,45	2 x 2,10	2 x 2,30	2 x 2,45

series "Infra HT.2 PIEZO" and "Infra HT.2 eco PIEZO"

Model, series Infra HT.2 PIEZO		4.2 PIEZO	6.2 PIEZO	8.2 PIEZO
Weight, series Infra HT.2 PIEZO	(kg)	13	16	19
Model, series Infra HT.2 eco PIEZO		4.2 eco PIEZO	6.2 eco PIEZO	8.2 eco PIEZO
Weight, series Infra HT.2 eco PIEZO	(kg)	8	10	12
Number of ceramic plates	n°	4	6	8
Electric feeding		NO	NO	NO
NOx class		4	4	4
GAS G20				
Heat input MAX (Hs)	(kW)	7,2	9,6	16,1
Heat input MAX (Hi)	(kW)	6,5	8,6	14,5
Heat input MIN (Hs)	(kW)	-	-	-
Heat input MIN (Hi)	(kW)	-	-	-
GAS supply pressure	(mbar)	20,0	20,0	20,0
NOZZLE pressure MAX	(mbar)	15,5	14,0	14,0
NOZZLE pressure MIN	(mbar)	-	-	-
Gas consumption MAX	(Sm ³ /h)	0,69	0,91	1,53
Gas consumption MIN	(Sm ³ /h)	-	-	-
Nozzle diameter	(mm)	2,10	2,45	3,10
GAS G25				
Heat input MAX (Hs)	(kW)	7,2	9,6	16,1
Heat input MAX (Hi)	(kW)	6,5	8,6	14,5
Heat input MIN (Hs)	(kW)	-	-	-
Heat input MIN (Hi)	(kW)	-	-	-
GAS supply pressure	(mbar)	25,0	25,0	25,0
NOZZLE pressure MAX	(mbar)	13,7	14,0	14,5
NOZZLE pressure MIN	(mbar)	-	-	-
Gas consumption MAX	(Sm ³ /h)	0,80	1,06	1,78
Gas consumption MIN	(Sm ³ /h)	-	-	-
Nozzle diameter	(mm)	2,30	2,70	3,40
GAS G30				
Heat input MAX (Hs)	(kW)	7,0	9,3	13,5
Heat input MAX (Hi)	(kW)	6,5	8,6	12,5
Heat input MIN (Hs)	(kW)	-	-	-
Heat input MIN (Hi)	(kW)	-	-	-
GAS supply pressure	(mbar)	30,0	30,0	30,0
NOZZLE pressure MAX	(mbar)	28,2	28,0	28,0
NOZZLE pressure MIN	(mbar)	-	-	-
Gas consumption MAX	(kg/h)	0,51	0,68	0,99
Gas consumption MIN	(kg/h)	-	-	-
Nozzle diameter	(mm)	1,30	1,50	1,80
GAS G31				
Heat input MAX (Hs)	(kW)	7,0	9,3	13,5
Heat input MAX (Hi)	(kW)	6,5	8,6	12,5
Heat input MIN (Hs)	(kW)	-	-	-
Heat input MIN (Hi)	(kW)	-	-	-
GAS supply pressure	(mbar)	37,0	37,0	37,0
NOZZLE pressure MAX	(mbar)	36,2	35,7	35,7
NOZZLE pressure MIN	(mbar)	-	-	-
Gas consumption MAX	(kg/h)	0,50	0,67	0,97
Gas consumption MIN	(kg/h)	-	-	-
Nozzle diameter	(mm)	1,30	1,50	1,80

series "Infra HT.2 DS"

Model Infra HT.2 DS		4.2 DS	6.2 DS	8.2 DS	10.2 DS	12.2 DS
Number of ceramic plates	n°	4	6	8	10	12
Electric feeding		230 Volt - single phase - 50 Hz				
Weight, series Infra HT.2 DS	(kg)	11	13	15	17	19
NOx class		4	4	4	4	4
GAS G20						
Heat input MAX (Hs)	(kW)	7,2	9,6	16,1	18,3	22,2
Heat input MAX (Hi)	(kW)	6,5	8,6	14,5	16,5	20,0
Heat input MIN (Hs)	(kW)	5,4	7,2	12,1	13,8	16,7
Heat input MIN (Hi)	(kW)	4,9	6,5	10,9	12,4	15,0
GAS supply pressure	(mbar)	20,0	20,0	20,0	20,0	20,0
NOZZLE pressure MAX	(mbar)	15,5	14,0	14,0	15,0	16,0
NOZZLE pressure MIN	(mbar)	8,5	7,5	8,0	9,0	9,5
Gas consumption MAX	(Sm ³ /h)	0,69	0,91	1,53	1,75	2,12
Gas consumption MIN	(Sm ³ /h)	0,52	0,69	1,15	1,31	1,59
Nozzle diameter	(mm)	2,10	2,45	3,10	3,30	3,50
GAS G25						
Heat input MAX (Hs)	(kW)	7,2	9,6	16,1	18,3	22,2
Heat input MAX (Hi)	(kW)	6,5	8,6	14,5	16,5	20,0
Heat input MIN (Hs)	(kW)	5,4	7,2	12,1	13,8	16,7
Heat input MIN (Hi)	(kW)	4,9	6,5	10,9	12,4	15,0
GAS supply pressure	(mbar)	25,0	25,0	25,0	25,0	25,0
NOZZLE pressure MAX	(mbar)	13,7	14,0	14,5	16,0	16,0
NOZZLE pressure MIN	(mbar)	8,3	7,5	8,5	9,5	9,5
Gas consumption MAX	(Sm ³ /h)	0,80	1,06	1,78	2,03	2,46
Gas consumption MIN	(Sm ³ /h)	0,60	0,80	1,34	1,53	1,85
Nozzle diameter	(mm)	2,30	2,70	3,40	3,60	3,80
GAS G30						
Heat input MAX (Hs)	(kW)	7,0	9,3	13,5	17,9	21,7
Heat input MAX (Hi)	(kW)	6,5	8,6	12,5	16,5	20,0
Heat input MIN (Hs)	(kW)	5,3	7,0	10,2	13,4	16,3
Heat input MIN (Hi)	(kW)	4,9	6,5	9,4	12,4	15,0
GAS supply pressure	(mbar)	30,0	30,0	30,0	30,0	30,0
NOZZLE pressure MAX	(mbar)	28,2	28,0	28,0	28,5	28,1
NOZZLE pressure MIN	(mbar)	16,5	16,0	15,5	16,0	16,0
Gas consumption MAX	(kg/h)	0,51	0,68	0,99	1,30	1,58
Gas consumption MIN	(kg/h)	0,39	0,51	0,74	0,98	1,18
Nozzle diameter	(mm)	1,30	1,50	1,80	2,10	2,30
GAS G31						
Heat input MAX (Hs)	(kW)	7,0	9,3	13,5	17,9	21,7
Heat input MAX (Hi)	(kW)	6,5	8,6	12,5	16,5	20,0
Heat input MIN (Hs)	(kW)	5,3	7,0	10,2	13,4	16,3
Heat input MIN (Hi)	(kW)	4,9	6,5	9,4	12,4	15,0
GAS supply pressure	(mbar)	37,0	37,0	37,0	37,0	37,0
NOZZLE pressure MAX	(mbar)	36,2	35,7	35,7	36,2	36,2
NOZZLE pressure MIN	(mbar)	22,0	20,0	20,0	20,0	20,0
Gas consumption MAX	(kg/h)	0,50	0,67	0,97	1,28	1,55
Gas consumption MIN	(kg/h)	0,38	0,50	0,73	0,96	1,16
Nozzle diameter	(mm)	1,30	1,50	1,80	2,10	2,30

note – the unit "Infra HT 10.2 DS" is NOT in production yet

INSTALLATION

Ventilation of the ambients



IMPORTANT: heaters must be installed in well-ventilated and manned ambients, in compliance with current legislation

The unit leaves the combustion products into the environment in which it is used (equipment type A1). It is therefore necessary to **ensure ventilation and air changes of the premises in which the heater is installed**, realizing appropriate air outlet openings on the perimeter walls of the same, or creating a system of mechanical ventilation. To ensure a sufficient air change, the flow of air needed can be calculated using the following equation (UNI EN 13410):

$$V_{\text{tot}} = \Sigma Q_{\text{nb}} \times L$$

Where :

- V_{tot} air change flow rate in m^3/h
- ΣQ_{nb} total heating power installed in the premises in kW
- L air change coefficient (must be $\geq 10 \text{ m}^3/\text{h} / \text{kW}$)

IMPORTANT !!! air change coefficient "L" to be used **MUST NOT** be lower than **10 m^3/h for each kW of installed power**

For NO reason the heaters can be installed :

- in ambients used as residential ambient
- in rooms smaller than 12 m^3
- where wind speed is higher than 2 m/s

Positioning of the radiant heater

The heaters can be installed on walls / pillars, or hanging at ceiling. On request, we can provide **supports** (S hooks and chains are excluded) for suspension at ceiling (picture 1), or **wall brackets** to fix the heaters on the wall (picture 2) with **different angled positions for the heater**. The following figures will show you how to install all types of heaters.



picture 1 – with chains **series Infra HT.2**

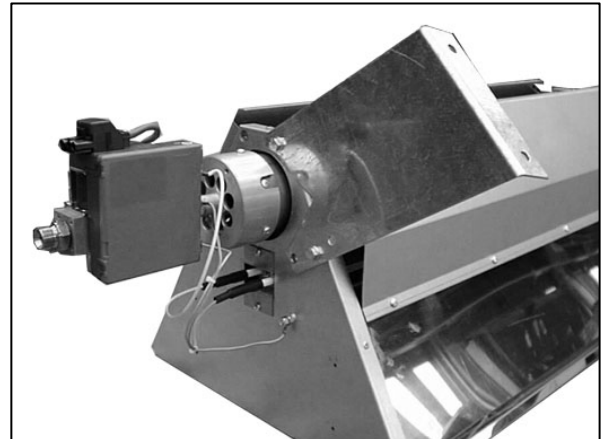

picture 2 – at wall **series Infra HT.2**

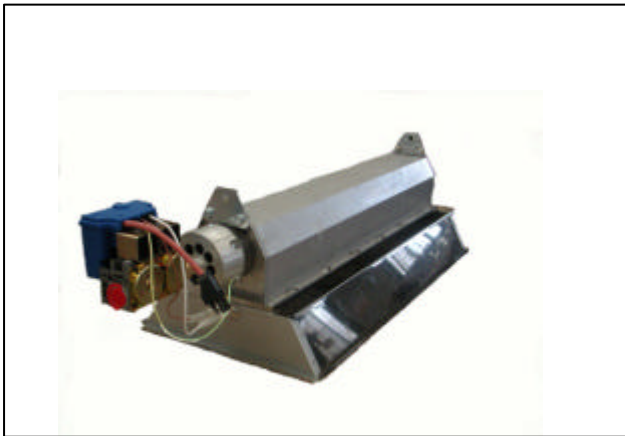

picture 1 – with chains **series Infra HT.2 eco**

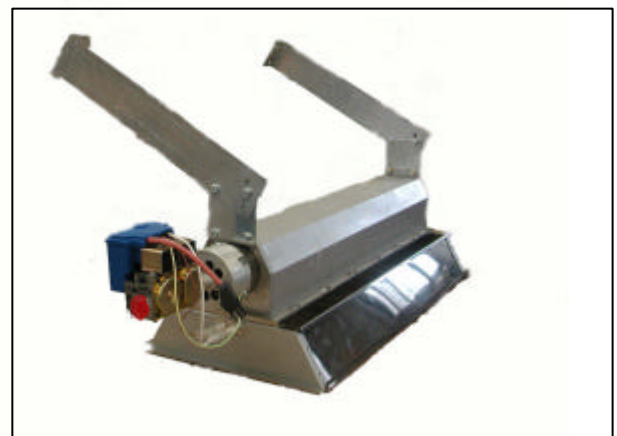

picture 2 – at wall **series Infra HT.2 eco**



picture 1 – with chains **series Infra HT.2 DS**



picture 2 – at wall **series Infra HT.2 DS**

The brackets provided by MARK BV allow an angle of installation variable once mounted on a wall or pillar, in order to get a better heat distribution (picture 2.1 shows supports for units type Infra HT.2 eco, Infra HT.2 eco PIEZO and Infra HT.2 DS)



picture 2.1 – different angles available

IMPORTANT !!!

- at each side of the burner 2 hooks are provided with M8 inserts, for fixing to a wall or at ceiling by means of appropriate brackets (not supplied, available on request); **do not create other anchor points on the carpentry of the heater and in particular on the body burner, but use only those designed by the factory**
- **we recommend MARK BV original brackets** for installation of the radiant heaters
- for fixing brackets on a wall or pillars **assess the consistency of walls and the load applied, in order to choose the correct anchors to be used**; in any case provide blocks with M8 screw minimum diameter (e.g. anchor Fischer TA - M in steel, with M8 screw)

IMPORTANT !!!

The equipment must be installed **in horizontal position**.

In any case, the system of fixing / suspension must allow the thermal expansion of appliance (some millimeter depending on the model).

MINIMUM height of installation (for people confort)

The indicative heights for the installation of heaters are as follows :

MODEL	HEIGHT of INSTALLATION (mt)	
	MIN	MAX
Infra HT 4.2 PIEZO ; Infra HT 4.2 eco PIEZO	2,5	4,5
Infra HT 6.2 PIEZO ; Infra HT 6.2 eco PIEZO	3,5	5,0
Infra HT 8.2 PIEZO ; Infra HT 8.2 eco PIEZO	4,0	6,0
Infra HT 4.2 ; Infra HT 4.2 eco ; Infra HT 4.2 DS	2,5	4,5
Infra HT 6.2 ; Infra HT 6.2 eco ; Infra HT 6.2 DS	3,5	5,0
Infra HT 8.2 ; Infra HT 8.2 eco ; Infra HT 8.2 DS	4,0	6,0
Infra HT 10.2 ; Infra HT 10.2 eco ; Infra HT 10.2 DS	5,0	7,0
Infra HT 12.2 ; Infra HT 12.2 eco ; Infra HT 12.2 DS	6,0	8,0
Infra HT 16.2 ; Infra HT 16.2 eco	7,0	9,0
Infra HT 10+10.2 ; Infra HT 10+10.2 eco	8,0	11,0
Infra HT 12+12.2 ; Infra HT 12+12.2 eco	9,0	14,0
Infra HT 16+16.2 ; Infra HT 16+16.2 eco	10,0	18,0

Height "MIN" means the minimum distance at which the equipment should be installed so that people who are in radiated zone, **are not subject to excessive heat**.

Quotes relate to equipment **installed in horizontal position** for heaters with angled position (15 ÷ 45 °); the minimum height can be reduced roughly between a 5% (15 ° angle) and a 20% (45 ° angle).

Shares relate to installation with **ambient temperature of 10 ÷ 12 °C**; in case of ambients with higher or lower temperatures the minimum height of installation must be reviewed; consider a reduction of 5% (for temperatures lower of approx. 5 ° C) or increase of 5% (for temperatures higher of approx. 5 ° C).

Above **heights of installation are indicative**, consult us each case to select the correct unit and the best height of installation (in particular for limit values).

MINIMUM distances from flammable surfaces

IMPORTANT !!! The flammable materials inside the radiation could begin to burn and cause fires.



SURFACES CLOSE to HEATERS MUST BE DONE IN MATERIAL of CLASS 'A0' with respect TO FIRE RESPONSE (NOT COMBUSTIBLE and NOT INFIAMMABLE) and with DEGREE of RESISTANCE TO FIRE EQUAL or MORE THAN "REI 90"

Minimum distances of installation must be respected between the heating surface of the heater and the adjacent walls, **inside the area of radiation and outside**, if they are not protected against radiation or are flammable materials; in case below minimum distances can not be met, consider to mount screens for the heat.

Pay special attention also in cases of installing heaters above craneways.

The MINIMUM distances are as follows :

MODEL	MINIMUM distance (mt) between heater and ...			
	ceiling	floor	front	sides
Infra HT 4.2 PIEZO ; Infra HT 4.2 eco PIEZO	1,0	2,0	1,0	1,0
Infra HT 6.2 PIEZO ; Infra HT 6.2 eco PIEZO	1,0	2,5	1,0	1,0
Infra HT 8.2 PIEZO ; Infra HT 8.2 eco PIEZO	1,5	3,0	1,5	1,5
Infra HT 4.2 ; Infra HT 4.2 eco ; Infra HT 4.2 DS	1,0	2,0	1,0	1,0
Infra HT 6.2 ; Infra HT 6.2 eco ; Infra HT 6.2 DS	1,0	2,5	1,0	1,0
Infra HT 8.2 ; Infra HT 8.2 eco ; Infra HT 8.2 DS	1,5	3,0	1,5	1,5
Infra HT 10.2 ; Infra HT 10.2 eco ; Infra HT 10.2 DS	1,5	3,5	1,5	1,5
Infra HT 12.2 ; Infra HT 12.2 eco ; Infra HT 12.2 DS	1,5	4,0	2,0	1,5
Infra HT 16.2 ; Infra HT 16.2 eco	1,5	4,5	2,0	1,5
Infra HT 10+10.2 ; Infra HT 10+10.2 eco	2,0	5,0	2,5	2,0
Infra HT 12+12.2 ; Infra HT 12+12.2 eco	2,0	5,5	2,5	2,0
Infra HT 16+16.2 ; Infra HT 16+16.2 eco	2,0	6,0	2,5	2,0

NOTE – contact us in case of different quotes or special cases

Connection to gas supply

IMPORTANT !!! hydraulic connection of the heater to the gas distribution net must be made according to information given in this technical book exclusively by professionally qualified staff

The heaters are provided according to the type of gas chosen, and then before making the connection to the power network of gas, **make sure that the gas used corresponds to what is shown on the data plate label** of the unit. **Before connection to the gas pipeline, make sure that the pipes are properly cleaned and produced in accordance with regulations in force in the country of installation.**

>>> **NOTICE** : provide a **fuel interception tap** in the vicinity of the heater, and with easily accessible position; make the **connection between the heater and the gas network using an approved steel flexible pipe.**

Once the connection is made, **in compliance with the rules in force in the country of installation**, **a)** verify the sealing of hydraulic pipes and gas connection to the unit, **b)** check that the pressure is correct, **c)** make sure that the apparatus functions in the conditions for which it was prepared.

- **Models Infra HT.2 , Infra HT.2 eco and Infra HT.2 DS** : the connection is 1/2" gas. The models Infra HT.2, Infra HT.2 eco and Infra HT.2 DS are equipped with a multifunctional group composed of double seat valve fitted with pressure stabilizer and integrated flame control. The **stabilizer accepts a maximum inlet pressure of 50 mbar** and the valve is equipped with a pressure intakes, to measure and control incoming and outgoing pressures.
- **Models Infra HT.2 PIEZO and Infra HT.2 eco PIEZO** : the connection is 3/8" gas. The Infra HT.2 PIEZO and Infra HT.2 eco PIEZO models are equipped with valve tap, **pressure stabilizer for a maximum inlet pressure of 50 mbar**, and pressure intake at the nozzle.

NOTE : all units are **supplied already tested and set** to the properly operating pressure; therefore **DO NOT remove seals, DO NOT change the values** (expiring of guarantee !!!)



IMPORTANT !!! the feeding gas pipeline **must be kept at a distance of at least 1 m from the zone of discharge of the combustion products and must not be exposed all'irraggiamento direct irradiation of heaters**

Connection to electric supply (only for units with flame control)



IMPORTANT: the electrical connection of the equipment shall be made in accordance with the directions given in this technical book exclusively by professionally qualified personnel. The installation must be carried out in accordance with regulations in the country of installation.

The heater must be fed with 230V / Single Phase / 50Hz voltage. The control flame mounted on gas valve has a plug/socket connection with security hook (picture 3). Mount a bipolar switch upstream of the heater for switch-on and switch-off, so you can isolate it from electric supply. Use this manual for the size of the power supply line, or refer to the data given in the plate label of the heater. In any case, for ON-OFF version use a cable 3x1.5mm² minimum section. The wiring diagrams are shown on page 20 (ON-OFF version) and page 23 (H/L = TWO-STAGES version) of this manual.

For the electrical connection unlock the plug and unscrew its case; connect a tri-polar cable according to the indications given on the terminal plug, namely:

- L1** phase wire
- N** neutral wire
-  earth wire
- L2** modulator command for H/L = two-stages gas valve (if provided)
- L3** signal for burner block (if provided)



IMPORTANT: It is **essential** for the smooth functioning of the heater, to **respect the Phase / Neutral polarity of the network**, with one indicated on the power connector.

It is also **essential** for the smooth functioning of the appliance, and for the safety of the user, an **efficient plant earthing**, executed according to existing regulations. Under no circumstances you can use the conduit connection of gas as earthing of equipment.

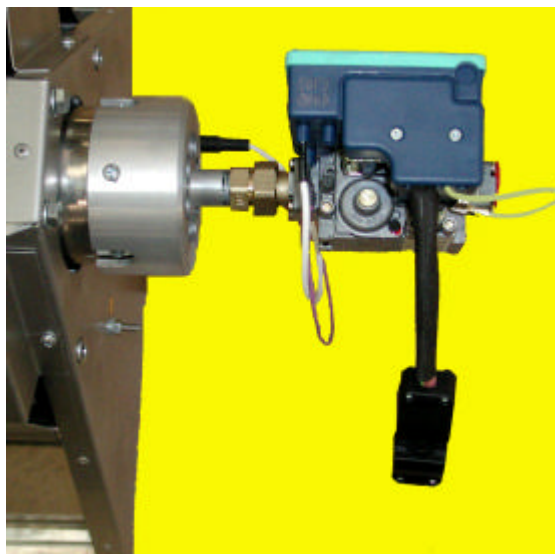

Picture 3 – Connector for electric connection

WIRING DIAGRAM, "SIT" control unit ON-OFF

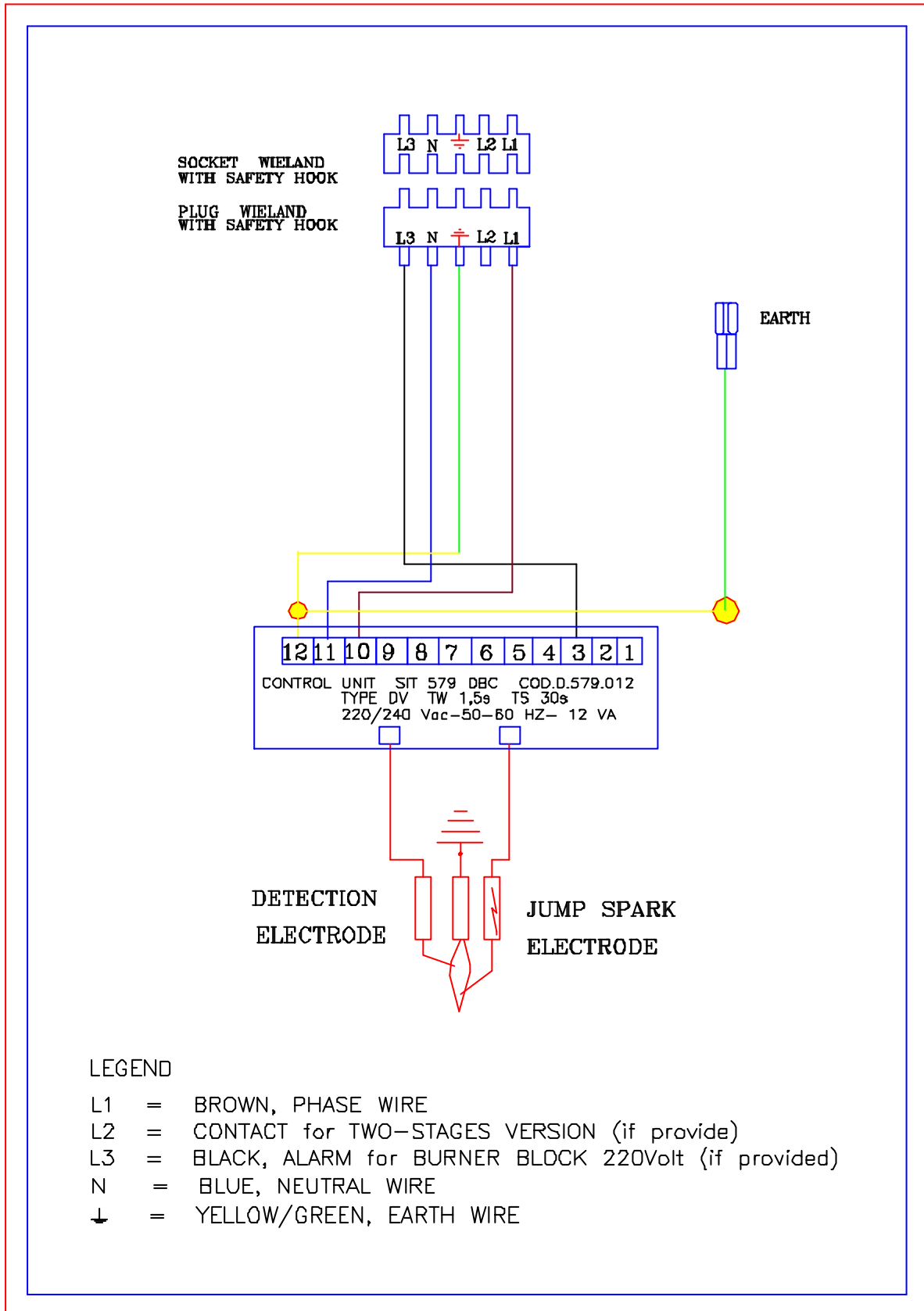

NOTE for SIT "HIGH / LOW" gas valve = two-stages

>>> NOTICE : the "HIGH / LOW " version must be equipped with a specific switch for pressure modulator feeding, to be placed in the main electric switchboard.

Modulator fed: HIGH pressure running
Modulator NOT fed: LOW pressure running

IMPORTANT !!! start-up of the heater **must always take place** with the modulator fed (HIGH pressure running)

You will find the data (heat input, pressure and gas flow rate) referring to the apparatus with H/L = TWO-STAGES version, in the tables of this manual :

- . heaters **Infra HT.2 and Infra HT.2 eco** page 5
- . heaters **Infra HT.2 DS** page 7

The H/L = TWO-STAGES version allows :

- save on gas consumption
- better confort condition for people
- lower number of start-up / switch-off of the heater

Setting of the pressure

Unscrew the screw of the **PO** pressure intake of the gas valve before the nozzle (pictures 1.A and 1.B), and connect a water column manometer. Feed the modulator and take out the yellow tap of the pressure regulator. Act, as shown in picture 2, on the CH10 screw for setting of the maximum pressure, till you get the required pressure. Take out tension at the pressure modulator, and with a screw-driver act on the inner screw for minimum setting (picture 3) till you get the required pressure.

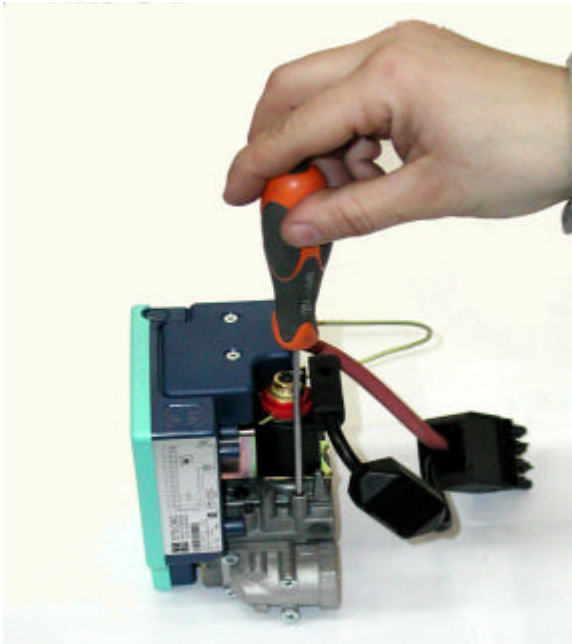

Picture 1.A

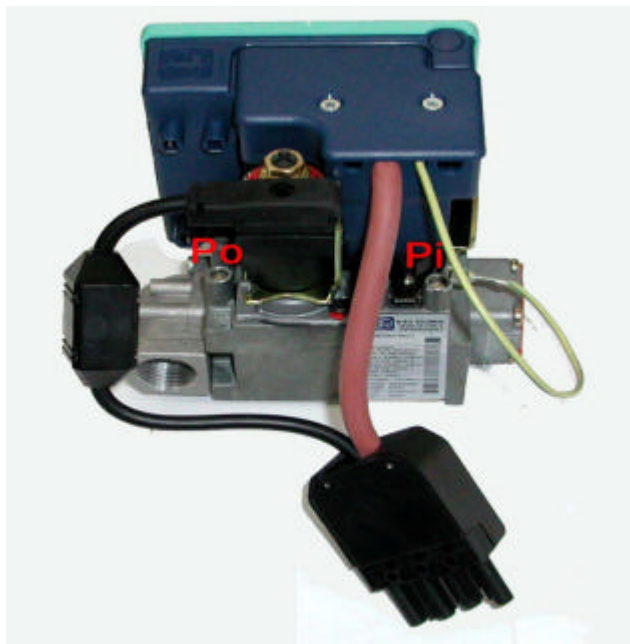

Picture 1.B



Picture 2

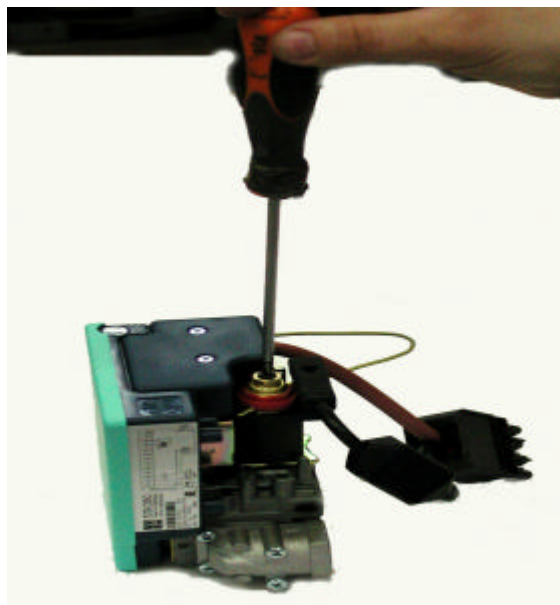

Picture 3

WIRING DIAGRAM, SIT control unit H/L = TWO-STAGES

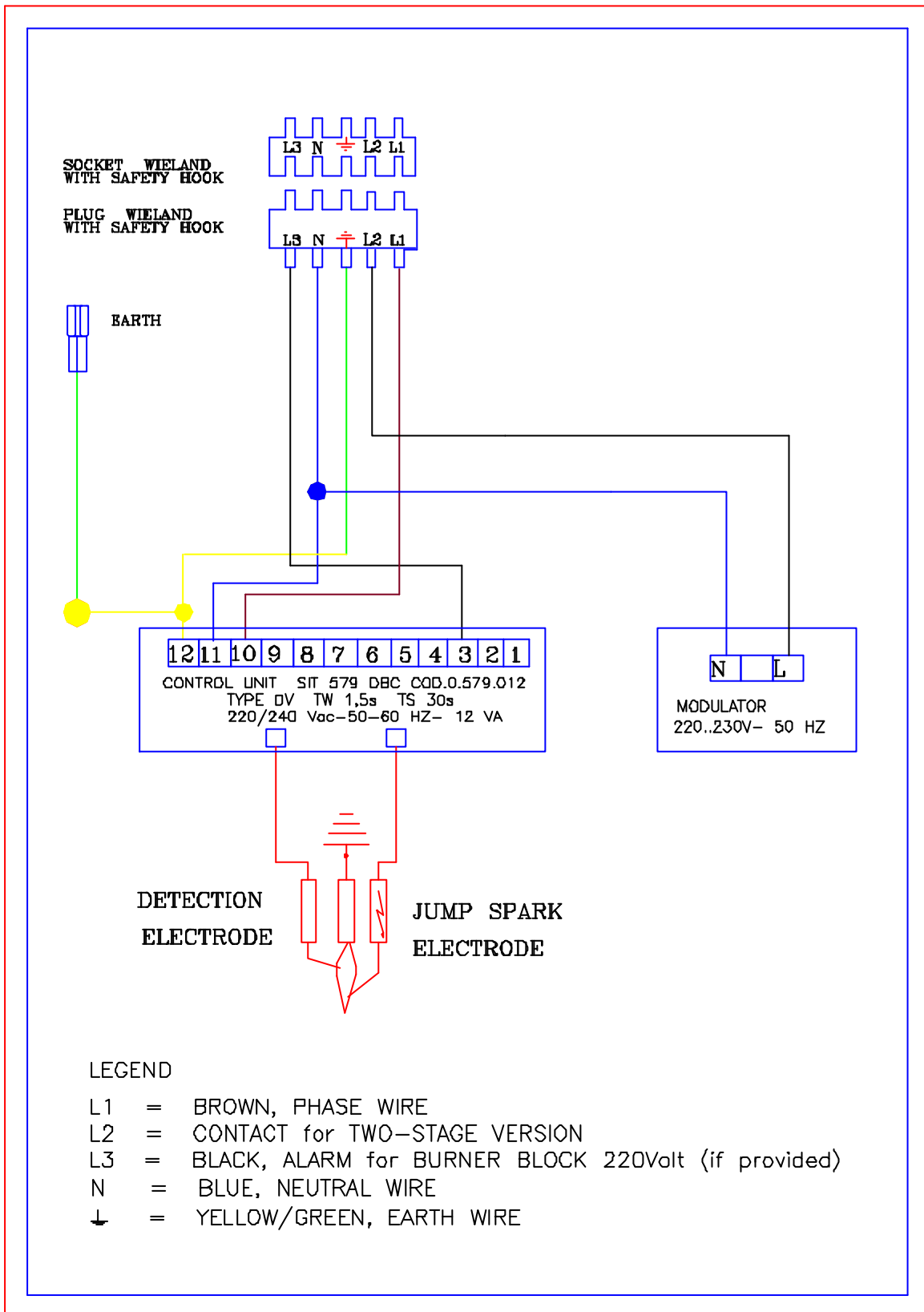

PUT IN OPERATION and FIRST START-UP

When the first ignition of heater is important to **do some preliminary checks** to ensure proper operation of the unit. The operations listed below are considered essential for its safe operation.

- make sure there are no losses in the gas line and that is properly sized
- check that the pressure of fuel and type of gas used comply with the provisions on the plate of the characteristics of the heater
- check the proper installation of gas valve / control flame group (only models Infra HT.2, Infra HT.2 eco and Infra HT.2 DS)
- check that the power electric line has been correctly sized, which has been respected phase - neutral polarity and that the cable earthing is connected (only models Infra HT.2, Infra HT.2 eco and Infra HT.2 DS)
- make sure the mechanical installation (supports) of the heater have been properly carried out and that the connections bolts are tight
- use only steel materials, since heat is transferred from heaters to supports

Put in operation and First Start-up for units with ELECTRONIC CONTROL UNIT (Infra HT.2, Infra HT.2 eco and Infra HT.2 DS)

For the heaters with an ignition system and electronic control flame, the start-up sequence includes the following phases:

- giving tension to the heater, ignition electrode begins sparking, and the gas valve opens
- the sparking electrode ends after 30 seconds
- in the case has not been detected the presence of flame, control flame goes into block after 30 seconds. For re-start it is necessary to remove tension for a period of not less than 20 seconds: after that period of time, the start-up sequence can be repeated. If the heater continues going into block, refer to the section 'Maintenance' of this manual
- switch-off of the heater is done by taking out power supply to control unit



IMPORTANT: at time of first start-up of the heater, **pressure setting has to be checked, then must be sealed the body of pressure regulator of gas valve**

So, must perform the following procedure (picture 4) :

- unscrew the screw of intake pressure, upstream at the nozzle (PO) and connect a suitable gauge
- remove the cap of pressure regulator (R) and act, as shown in picture 4, on the screw of adjustment till match up to the pressure gauge reading with that stated on plate on the characteristics
- disconnect the pressure gauge and close the screw of intake pressure (PO)
- reassemble the cap of the regulator (R) and place a suitable seal

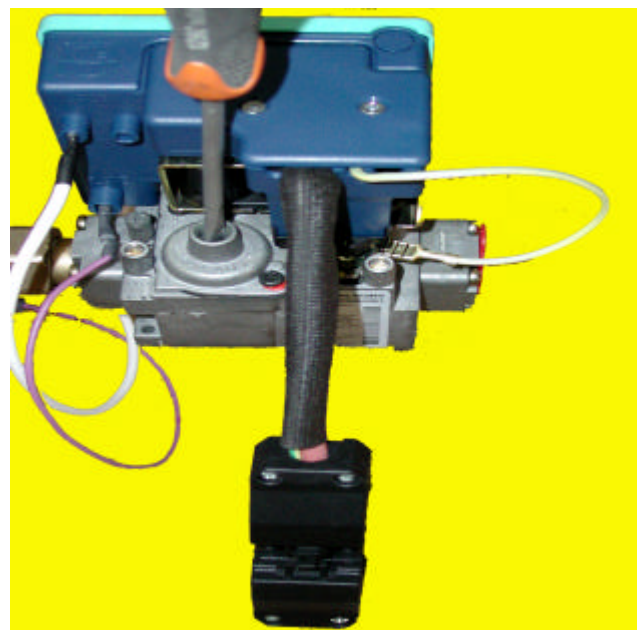
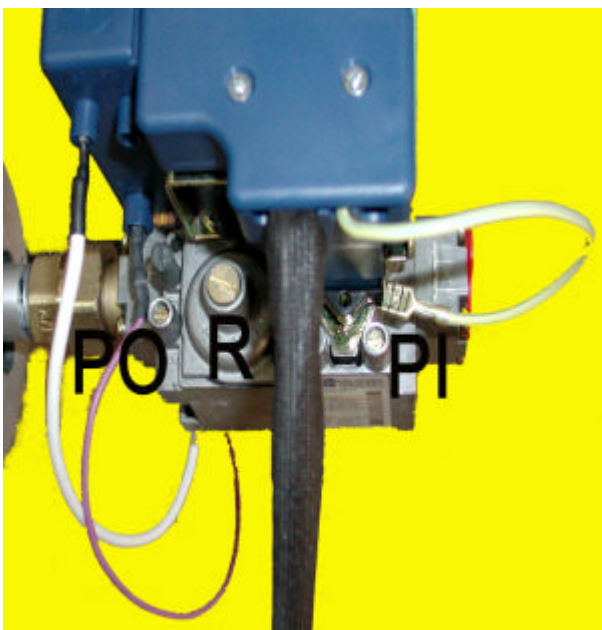

Picture 4 – Setting of working pressure for
models Infra HT.2, Infra HT.2 eco and Infra HT.2 DS with “SIT” valve

Put in operation and First Start-up for units with MANUAL START-UP / PIEZO (Infra HT.2 PIEZO and Infra HT.2 eco PIEZO)

The sequence of ignition for heaters with **manual start-up system / piezo** (picture 5) is :

- press the button of gas valve
- simultaneously push the button of the piezo starter until ignition occurred
- hold the button of the valve about 10sec. or until the activation of electromagnetic part of the thermocouple
- switch-off of the heater is done simply by closing the gas feeding

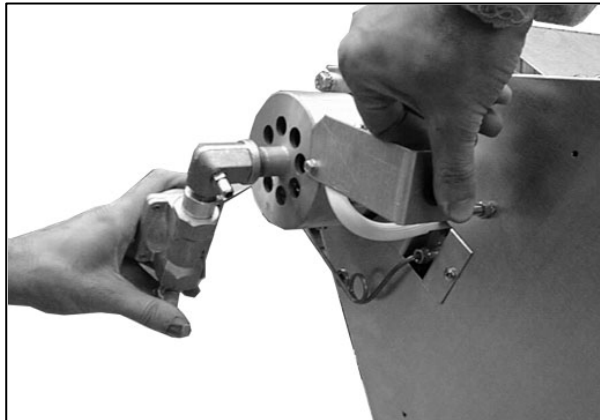

picture 5 – start-up for **models Infra HT.2 PIEZO and Infra HT.2 eco PIEZO**



IMPORTANT: at time of first start-up of the heater, **pressure setting has to be checked, then must be sealed the body of pressure regulator of the stabilizer.**

So, must perform the following procedure (picture 6) :

- unscrew the screw of the intake pressure, upstream at the nozzle POM and connect a suitable gauge
- remove the cap of the pressure regulator RM and act as shown in picture 6, on the screw of adjustment till match up to the pressure gauge reading with that stated on plate on the characteristics
- disconnect the pressure gauge and close the screw of the intake pressure POM
- reassemble the cap of the regulator RM and place a suitable seal

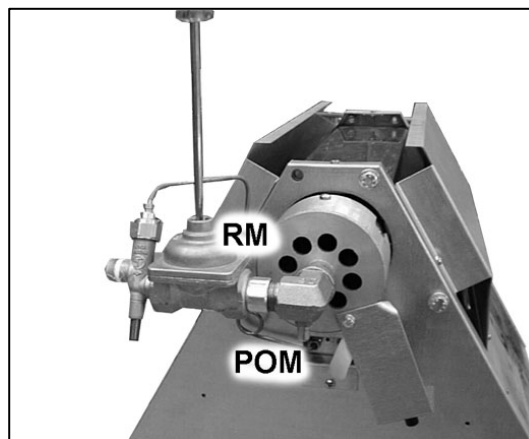

picture 6 – Setting of working pressure for
models Infra HT.2 PIEZO and Infra HT.2 eco PIEZO

MAINTENANCE

An appropriate use of the heaters, plus their proper and regular maintenance are essential to ensure better performance and longer working life to the heater.



IMPORTANT: before making any routine maintenance, make sure that both the gas and the power supply have been excluded, and that the apparatus is cold. For all routine and / or extraordinary maintenance, contact only professionally qualified staff, or rather a Technical Assistance Centre authorized by MARK BV

At least once a year before the season of use, it is strongly advisable to perform an intervention for control / inspection and cleaning:

- visual inspection of radiant surface (if any cracked ceramic plate)
- cleaning of radiant surface with compressed air at LOW PRESSURE from inside
- nozzle cleaning
- electrodes cleaning, correct position and efficiency sparking
- check of keeping all the electrical connections
- search for possible losses on the gas circuit and gas valve
- check of gas pressure at nozzle
- overall control of all components of the heater
- control of openings and ventilation systems (natural and/or mechanical)
- control of alarm signals, if any

If the equipment is installed in dusty environments is advisable to clean more frequently the burners blowing compressed air at low pressure, working from holes in the flange / venturi pipe. In case the heater is running, shut it down and wait, before you blow, that it is cool.

NOZZLE REPLACEMENT

In case you need to change the type of gas for which the heater was prepared, you should contact MARK BV to get the specific transformation kit, specifying the model of heater, serial number and the new gas. The operations must be performed by qualified personnel and in compliance with the regulations.



IMPORTANT: If you change the nozzle to move to a different type of gas (f.e.: from natural gas G20 to LPG G30 or vice versa) **it is compulsory to change also the plate label, placing a label with the new features, and put seal again after operation**

for heaters with 4, 6, 8, 10 and 10+10 ceramic plates

- use a CH13 spanner to unscrew and take out the gas nozzle
- screw properly new gas nozzle

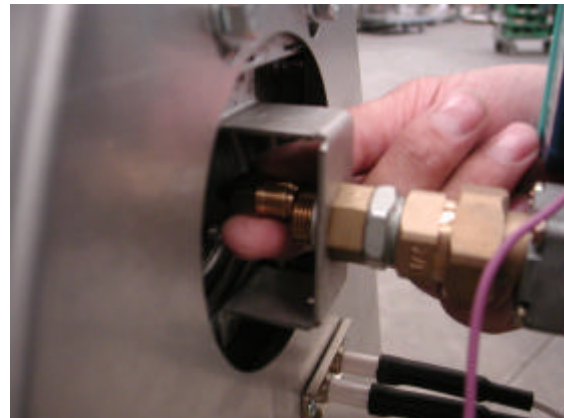
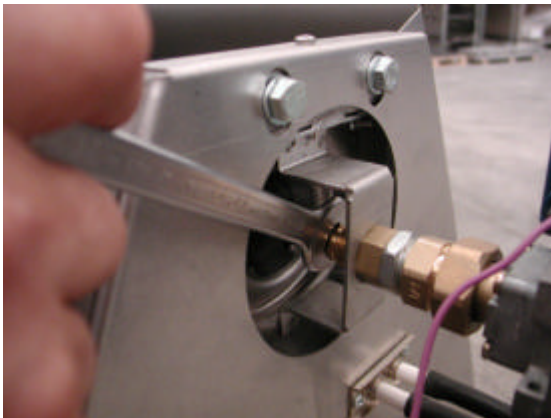

for heaters with 12, 16, 12+12 and 16+16 ceramic plates

- unscrew the 3 screws (pos. 1) and take out the aluminium flange (pos. 2)
- use a CH13 spanner to unscrew and take out the gas nozzle (pos. 3)
- screw properly new gas nozzle, mount the flange and screw blocking screws

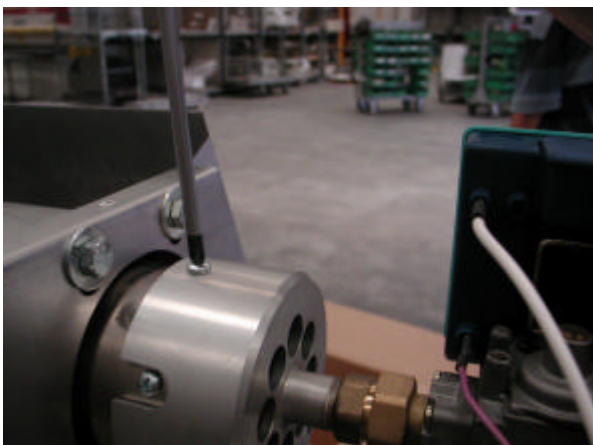

Trouble shooting

TROUBLE	POSSIBLE CAUSE	SOLUTION
A the heater turns on, the ignition electrode continues to sparkle then goes to block	A1 Phase and Neutral with wrong connection A2 The flame detection electrode is too far from the plates superfaces A3 The control unit is defective	A1 Check Phase / Neutral polarity and eart connection A2 Verify that the flame detection electrode is approx. 4 mm from the radiant surface A3 Replace the control unit
B the heater turns on partially	B1 Insufficient gas flow B2 Inlet gas pressure of the burner is too low B3 Dirty nozzle	B1 Check that gas supply has sufficient flow rate compared to gas consumption of the heater B2 Check that the gas pressure corresponds to that shown on the plate label B3 Clean nozzle with compressed air (NO mechanical device)
C the burner does flash-back	C1 Inlet gas pressure of the burner is too high C2 Burner or ceramic plates are dirty C3 Ceramic plates are cracked	C1 Check that the gas pressure corresponds to that shown on the plate label C2 After burner is cold, blow air at low pressure on the ceramic plates surface, from inside C3 Replace the ceramic plates
D the heater doesn't turn because no gas is getting	D1 Interruption in the elctric plant D2 No tension D3 Solenoid valve is live, but coils are not energized	D1 Verify voltage at connector of power supply D2 Replace the control unit D3 Replace the gas valve
E the ignition electrode doesn't sparkle, and burner goes to block	E1 The electrode doesn't spark because of wrong distance between its tip and earth E2 Power interruption E3 The spark of the ignition electrode starts close to the ceramic protection, due to its breakcage, or between cable and mass	E1 Adjust distance (closer or further) between tip of ignition electrode and mass : should be 3 ÷ 4 mm E2 Check contacts connection of electrodes and control unit E3 Replace the whole ignition and detection device or just the cable, or just the electrode
F the gas valve turns on, but the heater doesn't turn and goes to block	F1 Air in the gas pipe F2 No gas	F1 Repeat the ignition cycle several times, waiting a time of approx. 20 sec between an ignition and the other F2 Verify that all devices of fuel interception, on gas pipeline, do not prevent passage



Numero / Number	9100	Sostituisce / Replaces	-
Emesso / Issued	18/04/2008	Scopo / Scope	Directive 90/396/CEE

Rapporto / Report : 300965

Pag. 1 di 2

*Product Conformity Certificate***Kiwa Italia certifica che***Kiwa Italia hereby declares that***i prodotti riportati nelle pagine seguenti, commercializzati da***the products mentioned in the following pages, marketed by***MARK B.V.**

di / in Veendam, Nederland

soddisfano i requisiti riportati nella

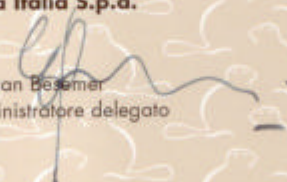
*meet the essential requirements as described in the***Direttiva Apparecchi a Gas (90/396/CEE)***Directive on appliances burning gaseous fuels (90/396/CEE)***Kiwa Italia S.p.a.**

 Adriaan Beemer
 Amministratore delegato

E' permessa la pubblicazione del certificato.
Publication of the certificate is allowed.

Kiwa Italia S.p.a.Sede legale:
Via G. Carducci, 5
20123 MilanoSede Amministrativa e operativa:
Via Treviso, 32/34
31020 San Vendemiano (TV)**GASTEC****Notified Body****0694**



Product Conformity Certificate



Numero / Number | 9100 Sostituisce / Replaces -
 Emesso / Issued | 18/04/2008 Scopo / Scope Directive 90/396/CEE

Rapporto / Report : 300965

Pag. 2 di 2

diffusori termici a gas ad irraggiamento luminoso, tipo
non-domestic overhead luminous radiant heaters, type

Marchio / trade mark:

- Infra HT 4.2
- Infra HT 6.2
- Infra HT 8.2
- Infra HT 10.2
- Infra HT 4.2 High / Low
- Infra HT 6.2 High / Low
- Infra HT 8.2 High / Low
- Infra HT 10.2 High / Low
- Infra HT 4.2 eco
- Infra HT 6.2 eco
- Infra HT 8.2 eco
- Infra HT 10.2 eco
- Infra HT 4.2 eco High / Low
- Infra HT 6.2 eco High / Low
- Infra HT 8.2 eco High / Low
- Infra HT 10.2 eco High / Low
- Infra HT 4.2 DS
- Infra HT 6.2 DS
- Infra HT 8.2 DS
- Infra HT 10.2 DS
- Infra HT 4.2 DS High / Low

MARK Infra HT

- Infra HT 6.2 DS High / Low
- Infra HT 8.2 DS High / Low
- Infra HT 10.2 DS High / Low
- Infra HT 4.2 PIEZO
- Infra HT 6.2 PIEZO
- Infra HT 8.2 PIEZO
- Infra HT 4.2 eco PIEZO
- Infra HT 6.2 eco PIEZO
- Infra HT 8.2 eco PIEZO
- Infra HT 4.2 MD
- Infra HT 6.2 MD
- Infra HT 4.2 MR
- Infra HT 6.2 MR
- Infra HT 6.2 ST
- Infra HT 8.2 ST
- UFO HT E
- UFO HT E High/Low
- UFO HT M
- Infra HT 10+10.2
- Infra HT 10+10.2 eco

- Infra HT 10+10.2 High / Low
- Infra HT 10+10.2 eco High / Low
- Infra HT 12.2
- Infra HT 12.2 eco
- Infra HT 12.2 High / Low
- Infra HT 12.2 eco High / Low
- Infra HT 12+12.2
- Infra HT 12+12.2 eco
- Infra HT 12+12.2 High / Low
- Infra HT 12+12.2 eco High / Low
- Infra HT 12.2 DS
- Infra HT 12.2 DS High / Low
- Infra HT 16.2
- Infra HT 16.2 eco
- Infra HT 16.2 High / Low
- Infra HT 16.2 eco High / Low
- Infra HT 16+16.2
- Infra HT 16+16.2 eco
- Infra HT 16+16.2 High / Low
- Infra HT 16+16.2 eco High / Low

commercializzati da /

marketed by
 di / in

MARK B.V.

Veendam, Nederland

NIP / PIN

: 0694BS0965

Rapporto / report

: 300965

Tipi di apparecchi / appliance type

: A₁

I suddetti prodotti sono stati approvati per
 Mentioned products have been approved for

AL	Il_2009	AT	Il_2009	BE	Il_2009	BG	Il_2009
CY	Il_2009	CZ	Il_2009	DE	Il_2009	DK	Il_2009
EE	Il_2009	ES	Il_2009	FI	Il_2009	FR	Il_2009
GB	Il_2009	GR	Il_2009	HU	Il_2009	IE	Il_2009
IS	Il_2009	IT	Il_2009	LT	Il_2009	LU	Il_2009
LV	Il_2009	MK	Il_2009	MT	Il_2009	NL	Il_2009
NO	Il_2009	PL	Il_2009	PT	Il_2009	RO	Il_2009
SE	Il_2009	SI	Il_2009	TR	Il_2009	HR	Il_2009
BIH	Il_2009	BY	Il_2009	MD	Il_2009	UA	Il_2009
YU	Il_2009	CH	Il_2009			SK	Il_2009

Kiwa Italia S.p.a.

Sede Legale:
 Via G. Carducci, 5
 20123 Milano

Sede Amministrativa e operativa:
 Via Treviso, 32/34
 31020 San Vendemiano (TV)

GASTEC

Notified Body

0694

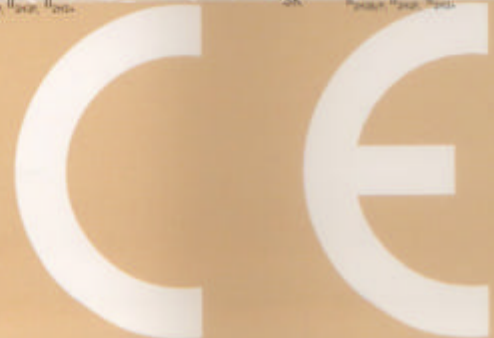

DATE and STAMP

OPERATION / NOTES

DATE and STAMP

OPERATION / NOTES

DATE and STAMP

OPERATION / NOTES

DATE and STAMP

OPERATION / NOTES

MARK BV
Beneden Verlaat, 87 – 89
9645 – BM Veendam
The Netherlands

to contact us :

Phone +31.0598.656600

Fax +31.0598.624584

E-mail info@mark.nl

Web page www.mark.nl